



广东宏磊达光电科技有限公司

Guandong Hongleida Optoelectronic Technology CO., LTD

产品说明书

(PART DESCRIPTION)

产品名称 (PRODUCT NAME)	大功率 LED 透镜
产品型号 (PRODUCT NO)	LHH2037Q-XP02
版本号 (EDITION NO)	01A
说明书编号 (MANUAL NO.)	20110621007
日期 (DATE)	2011. 06. 21



广东宏磊达光电科技有限公司

Guandong Hongleida Optoelectronic Technology CO., LTD

目录 (CATALOGUE)

产品照片 (Product photographs)	3
产品图纸 (Product drawings)	4
光照及角度曲线 (Illumination and Angle curve)	5
测试数据 (Test data)	6
系列产品 (Series products)	7
包装方式 (Packing)	8
使用说明 (Instructions)	9



广东宏磊达光电科技有限公司

Guandong Hongleida Optoelectronic Technology CO., LTD

LHH2037Q-XP02

产品照片 (Product photographs)



正面 (Face)



反面 (Inverse)

备注 (Note) :

(1) 透镜材料为 PMMA, 颜色为透明。

(Lens material is PMMA, and color is transparent.

(2) 禁止用任何工业溶剂清洗透镜, 例如酒精。

(Never use any commercial cleaning solvents on lenses, like alcohol.

Create fine products to serve the society!



产品图纸(Product drawings)

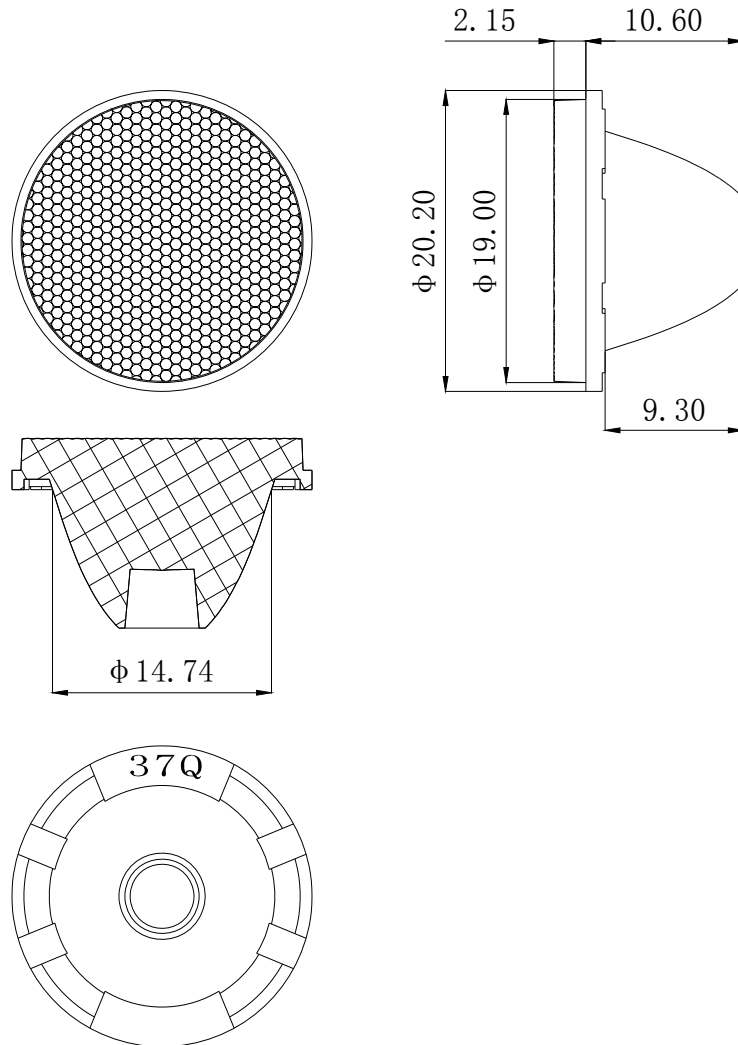

备注 (Note) :

(1) 必须按照上面规定的尺寸来制造产品。

(Specific size can be made according to requirements.)

(2) 这里所有的尺寸都为毫米, 图纸和产品是相对应的。

(The unit of all the dimensions is mm, and the drawing follows a certain proportion.)

(3) 工作时控制的温度变化范围: $-40^{\circ}\text{C} \sim +80^{\circ}\text{C}$

(Operating Temperature range $-40^{\circ}\text{C} \sim +80^{\circ}\text{C}$)

(4) 贮存温度: $0^{\circ}\text{C} \sim +40^{\circ}\text{C}$

(Storage Temperature range $0^{\circ}\text{C} \sim +40^{\circ}\text{C}$)

Create fine products to serve the society!



光照及角度曲线(Illumination and Angle curve)

Irradiance Chart

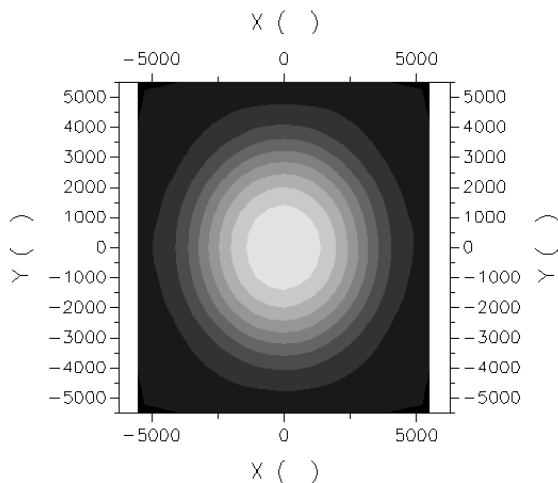

X (毫米) = 0, Y (毫米) = 0, Value = 2.37135e-008

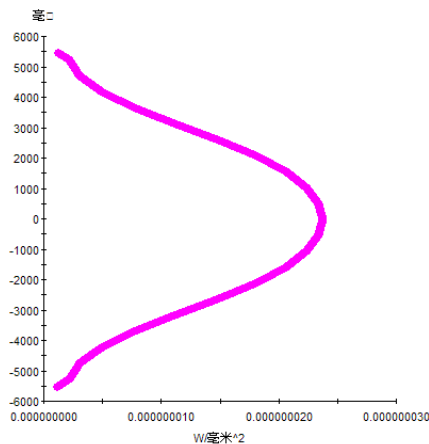

Current Y Slice (毫米)

15度.farFieldReceiver_72.Intensity Slices
强度 (%)

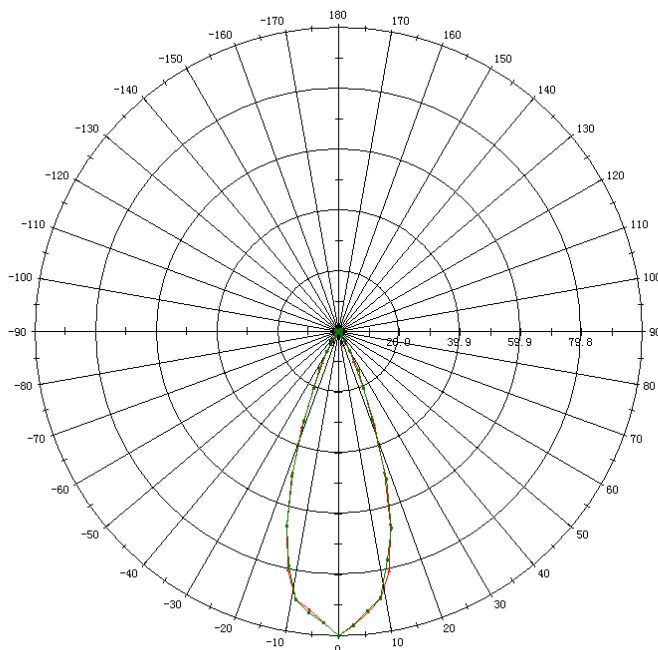

Total Collected Power = 879.35422 lm
Efficiency = 0.99971
Maximum Intensity = 1879.64745 cd

— I = 0.00000
— I = 90.00000





测试数据 (Test data)

光源 (LIGHT SOURCE)	透镜 (LENS)	出光角度 (Out Light Range Degree)			
		10%	25%	50%	75%
EVERLIGHT C06	LHH2037Q-XP02	60.4	48.9	32.3	20.4
EVERLIGHT C19	LHH2037Q-XP02	61.5	50.3	38.8	24.6
SAMSUNG 3535	LHH2037Q-XP02	64.6	54.7	45.4	21.0
GREE XPE	LHH2037Q-XP02	61.2	52.8	45.0	38.1
CREE XTE	LHH2037Q-XP02	58.9	48.6	38.8	28.9
CREE XBD	LHH2037Q-XP02	60.4	50.6	41.2	24.7
REBEL	LHH2037Q-XP02	56.2	44.6	27.1	17.0
天电 3535	LHH2037Q-XP02	60.1	50.6	41.7	33.1



系列产品 (Series Products)

型号 (Part NO)	外形尺寸 (Shape Size)	产品照片 (Product Photographs)
LHH2037Q-XP02-XPW3	φ 21.6*14	
LHH2037Q-XP02-XPW2	φ 22.4*13.6	
LHH2037Q-XP02-XBDW2	φ 22.4*13.6	



包装方式 (Packing)

1、LHH2037Q-XP02 包装方式 (packing):

1.1、包材 (Packaging material):

32*22*1.4CM 吸塑盒 (Clamshell boxes); 34*23*30CM 纸箱 (cartons);

1.2、数量 (QTY): 117PCS/盒*22 盒=2574PCS/箱;

1.3、包装示意图 (Packaging schemes):

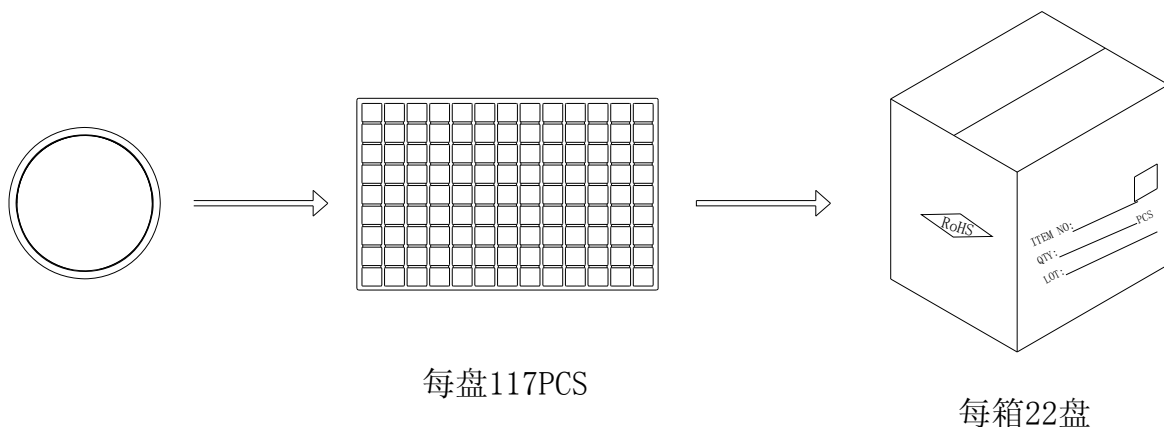

2、LHH2037Q-XP02-XPW3/XPW2/XBDW2 包装方式 (packing):

2.1、包材 (Packaging material):

22.5*24*1.5CM 吸塑盒 (Clamshell boxes); 51.5*27*18CM 纸箱 (cartons);

2.2、数量 (QTY): 72PCS/盒*24 盒=1728PCS/箱;

2.3、包装示意图 (Packaging schemes):

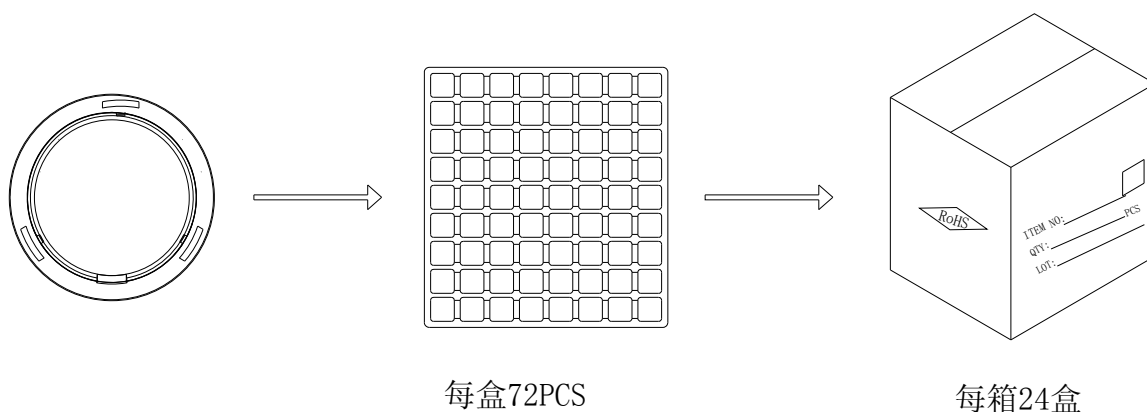



使用说明 (Instructions)

- (1) 如果必须清洗透镜请用少量水和柔软的布（无尘纸）擦拭。

(If necessary, clean lenses with mild soap, water and soft cloth.)

- (2) 禁止用工业溶剂清洗透镜，例如酒精。

(Never use any commercial cleaning solvents on lenses, like alcohol.)

- (3) 工作环境时透镜的温度控制在 $-40^{\circ}\text{C}\sim+80^{\circ}\text{C}$

(Lens operating Temperature range -40°C to $+80^{\circ}\text{C}$.)

- (4) 贮存环境要求，温度： $0^{\circ}\text{C}\sim40^{\circ}\text{C}$ ，湿度： $30\%\sim95\%$ 。

(Alternatively the following environment is recommended: Storage temperature: 0°C to 40°C , Humidity: 30% to 95% HR max.)

- (5) 透镜具有导光和聚光功能，由透明材料制成，污染后可直接影响其功能，于是在未使用请勿打开包装，预防灰尘等污染。

(This kind of lens can make the lighting more concentrated, and it's made from the transparent material, The functions will be affected once they were polluted, so please do not open the packages until you use them, in case of the dust and other pollutions.)

- (6) 避免阳光直射和其他带有紫外线的射线照射，易产生老化、变色、裂变等不良效果。

(Please Avoid the lens contacting with the sunlight and other ultraviolet radiations directly, it's very easy to produce the bad effects, such as aging, discoloration, fission and so on.)

- (7) 请在安装透镜时戴手套，透镜表面的磨损会影响其出光效果。

(Please handle or install lens with wearing gloves, skin oils may damage lens optical characteristic.)

- (8) 禁止用酸性或碱性溶剂接触产品，易产生化学反应。

(Please prohibit the acidic or alkaline solvent contacting with the lens directly, or the chemical reaction will be happened very easily.)